



International Academy of Astronautics – IAA
5th IAA Conference on University Satellite Missions and CubeSat
Workshop



NANOSATC-BR3 CONCEPT DESIGN USING MODEL-BASED SYSTEMS ENGINEERING (MBSE)

Artur Gustavo Slongo*, Lorenzo Quevedo Mantovani*, Nelson Jorge Schuch*, Otávio Santos Cupertino Durão, Fátima Mattiello-Francisco**, André Luís da Silva***, Andrei Piccinini Legg*** and Eduardo Escobar Bürger*****

* Southern Regional Space Research Center – CRCRS/COCRE/INPE-MCTIC, in collaboration with the Santa Maria Space Science Laboratory - LACESM/CT-UFSM, Santa Maria, RS, Brazil, arturgustavoslongo@gmail.com, lorenzo.mantovani@gmail.com, njschuch@gmail.com.

** National Institute for Space Research (INPE/MCTIC), São José dos Campos - SP, Brazil.

otavio.durao@inpe.br,
fatima.mattiello@inpe.br.

*** Federal University of Santa Maria - UFSM, Technology Center, Professors, Santa Maria - RS, Brazil.
n.br, andrei.legg@gmail.com, eduardoebg@gmail.com



Rome - Italy, 28th - 31th January 2020





SUMMARY

1. NANOSATC-BR program;
2. NANOSATC-BR3;
3. OBJECTIVES;
4. MODEL-BASED SYSTEM ENGINEERING;
5. CAPELLA - ARCADIA;
6. NCBR3 CONCEPT DESIGN WITH MBSE;
7. NCBR3 MISSION CONCEPT;
8. DISCUSSION;
9. CONCLUSIONS.

NANOSATC-BR PROGRAM

NANOSATC-BR1

- 1U platform and GS purchased from ISL/ISIS, through international bid in 2010;
- Magnetometer (INPE/MCTIC), Fault Tolerant FPGA (UFRGS) and IC on/off driver (SMDH/UFSM);
- Operational since 2014

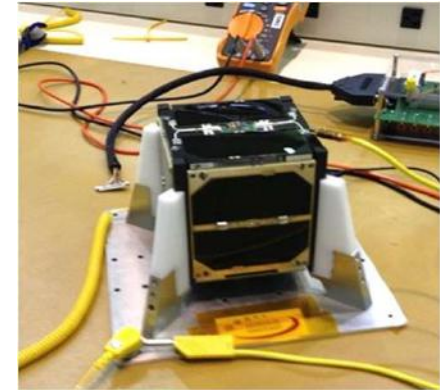

Figure 1 - NANOSATC-BR1

<http://www.inpe.br/crs/nanosat/galeria.php>

NANOSATC-BR2

- Langmuir Probe (INPE/MCTIC), Attitude Determination System (Cooperation INPE/MCTIC with UFMG - UFABC), Other ICs (SMDH and UFRGS) and two magnetometers;
- Currently at Assembly, Integration & Tests process.



Figure 1 - NANOSATC-BR2 EM

NANOSATC-BR3

- Currently in its **Conceptual Phase of Development**;
- To study **Space Radiation** and develop **Capacity building**;
- Constraint: **Reuse** NANOSATC-BR1 EM;
- Stakeholders and their needs:
 - **INPE Scientists** need to **validate a radiation protective material** in space.
 - **UFRN/CRN** technologists need to **validate their transceiver** in space environment.
 - **UFSM and UFRGS** technicians and Professors need to **validate their integrated circuits** against space radiation.
 - **Galileo Mission Scientists** need to **analyze the dynamics of trapped particles in radiation belts** and their influence on embedded electronics.

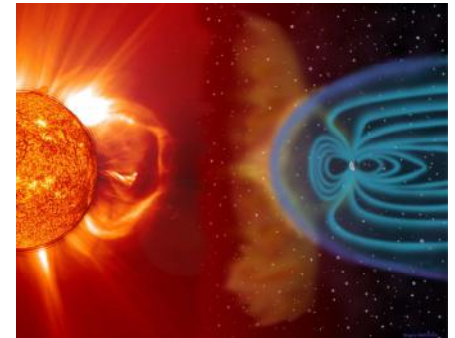

Figure 2 - NASA / SOHO

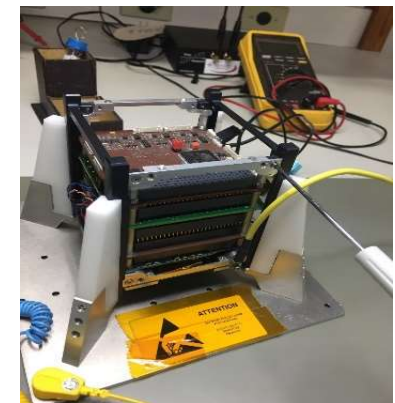
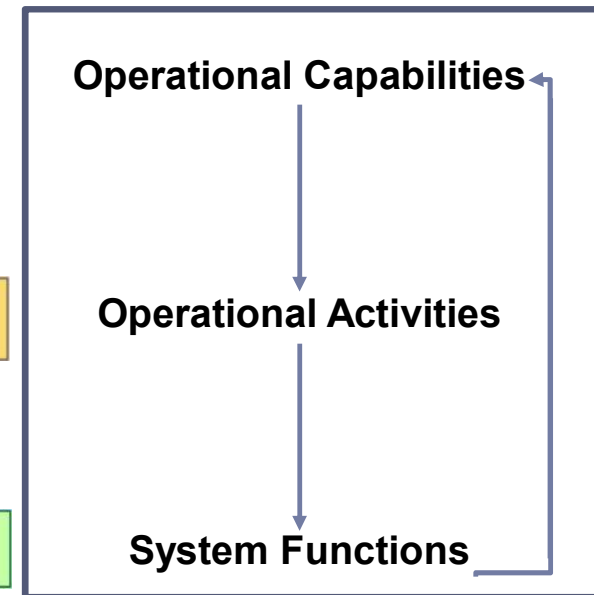
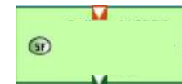
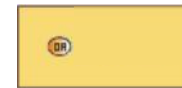

Figure 3 – NCB3 EM

OBJECTIVE

- ▶ Use an MBSE software with an embedded Systems Engineering method to:
 - ▶ Identify Mission needs and their interrelation;
 - ▶ Identify high level system functions;
 - ▶ Develop a mission concept;
 - ▶ Capture requirements;
 - ▶ Build the first NCBR3 Model;
 - ▶ Introduce the use of MBSE in the Program.





MODEL-BASED SYSTEM ENGINEERING

“Formalized application of modeling to support requirements definition, design, analysis, verification and validation activities”

- One of the main Goals:
 - **Integrate** information, communication and the analysis of systems engineering products.

- Modeling is based on three pillars:
 - **Tool**: Concerns to the instrument (usually software) that will be used to develop the work;
 - **Language**: Method of communication between the user and the tool (similar to a programming language);
 - **Method**: process that sometimes is conveniently embedded in the tool.



CAPELLA - ARCADIA

- Integration of all model views;
- Open source;
- Largely used by space industry;
- Meets all three pillars;
- Four steps of development;
- Interactive and recursive
- ⁷ method.

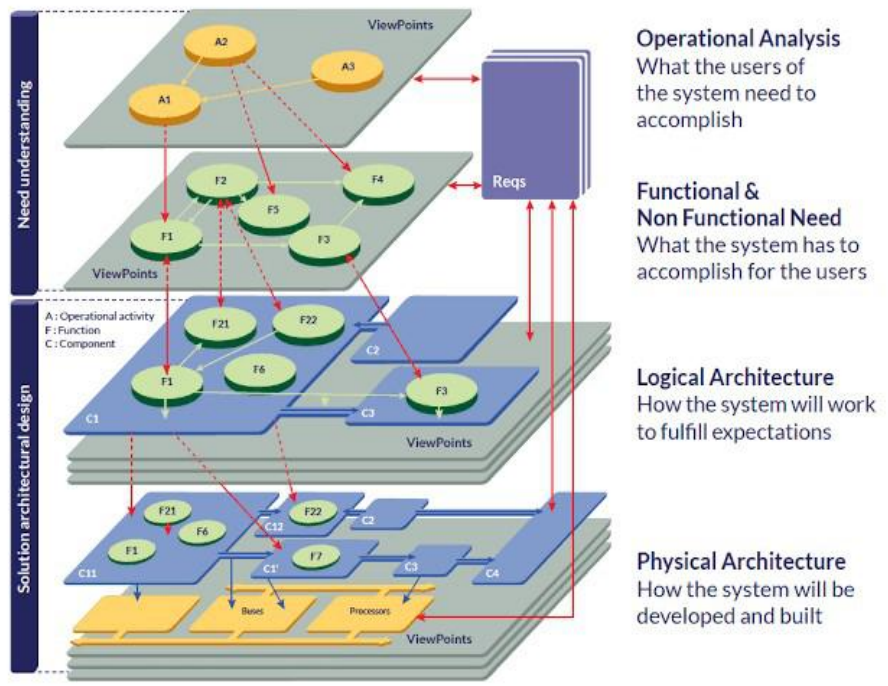

Figure 5: The Arcadia Method
 Source: <https://www.eclipse.org/capella/arcadia.html>

NCBR3 CONCEPT DESIGN WITH MBSE

Operational Capabilities:

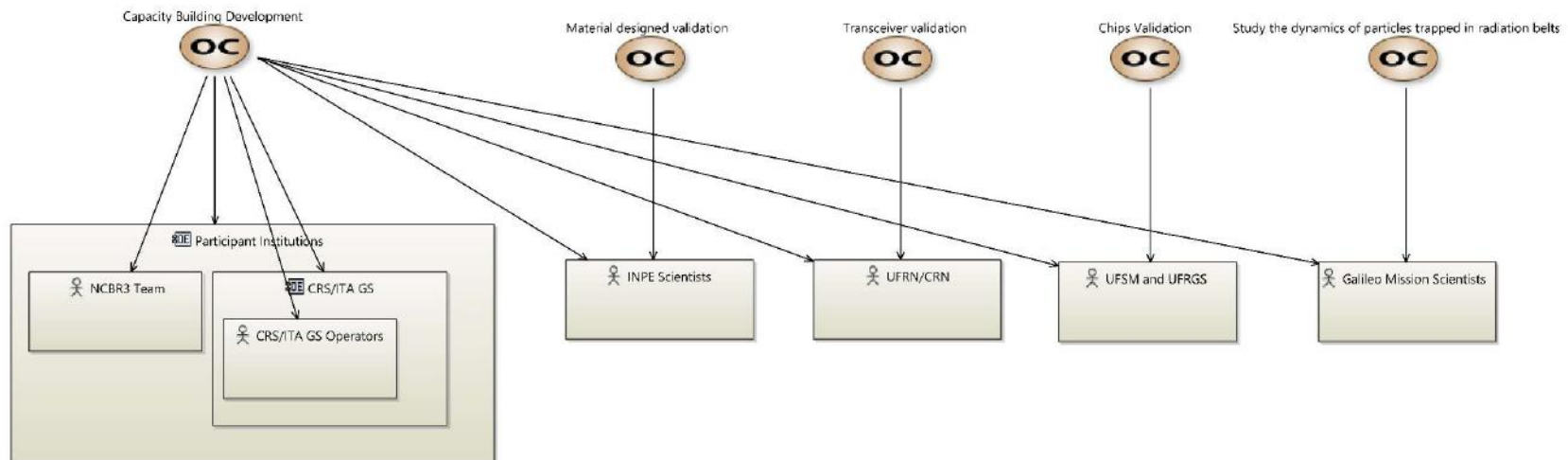
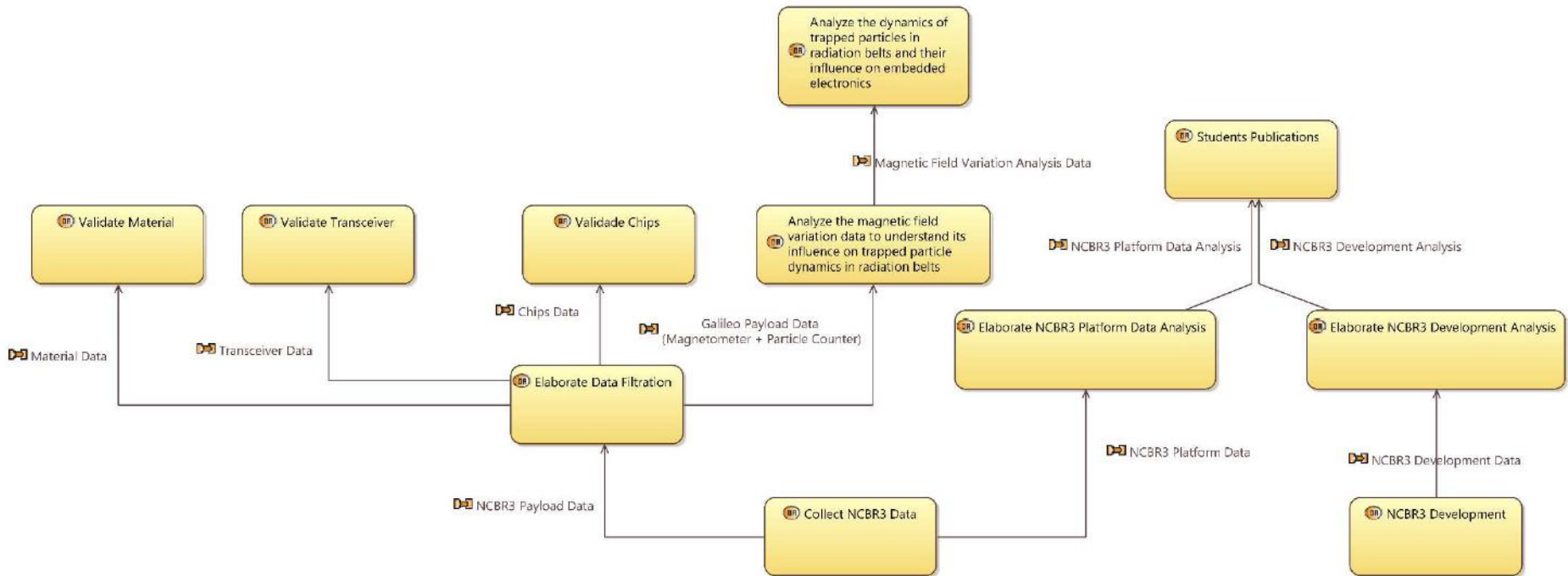

Figure 4: Operational Capabilities

- Operational Capabilities (Needs);
- Actors (Stakeholders).

NCBR3 CONCEPT DESIGN WITH MBSE

Operational Activities Interaction:



➤ Operational Activities;

Figure 6: Operational Activities Interaction



NCBR3 CONCEPT DESIGN WITH MBSE

Operational Architecture:

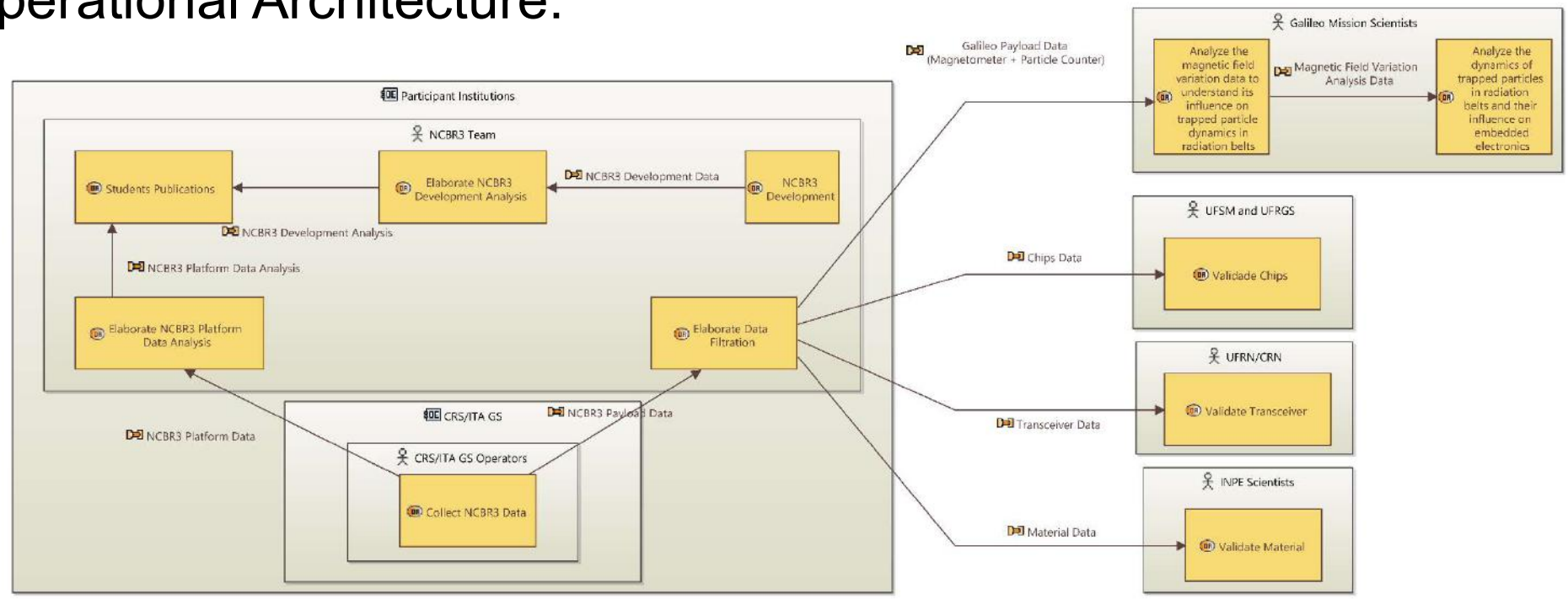

Figure 7: Operational Architecture

- Operational Activities;
 - Actors.
- ▶ 10



NCBR3 CONCEPT DESIGN WITH MBSE

System Architecture:

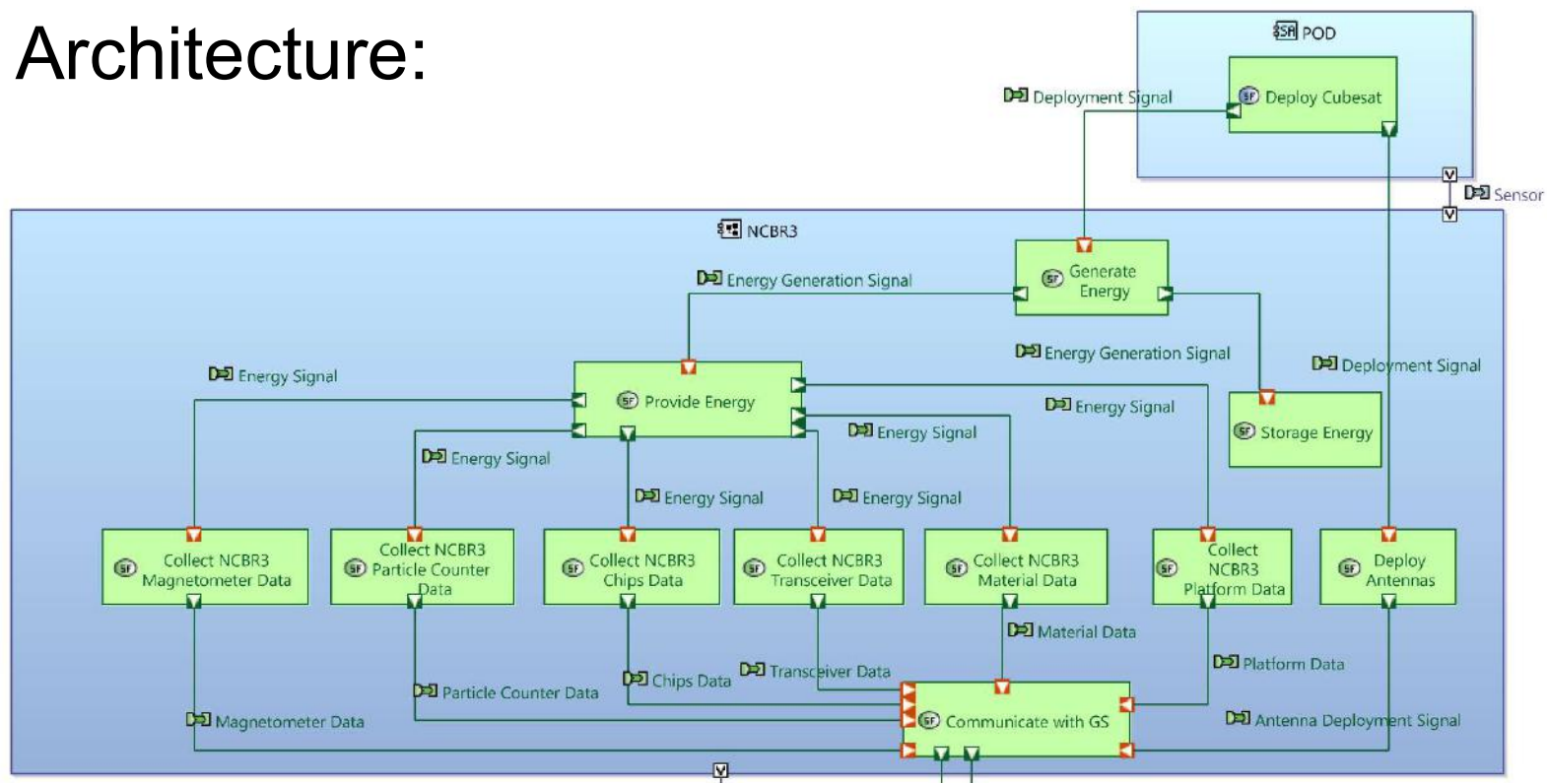

- Actors;
- System;
- System High-Level Functions.

Figure 8: System Architecture



NCBR3 CONCEPT DESIGN WITH MBSE

System Architecture:

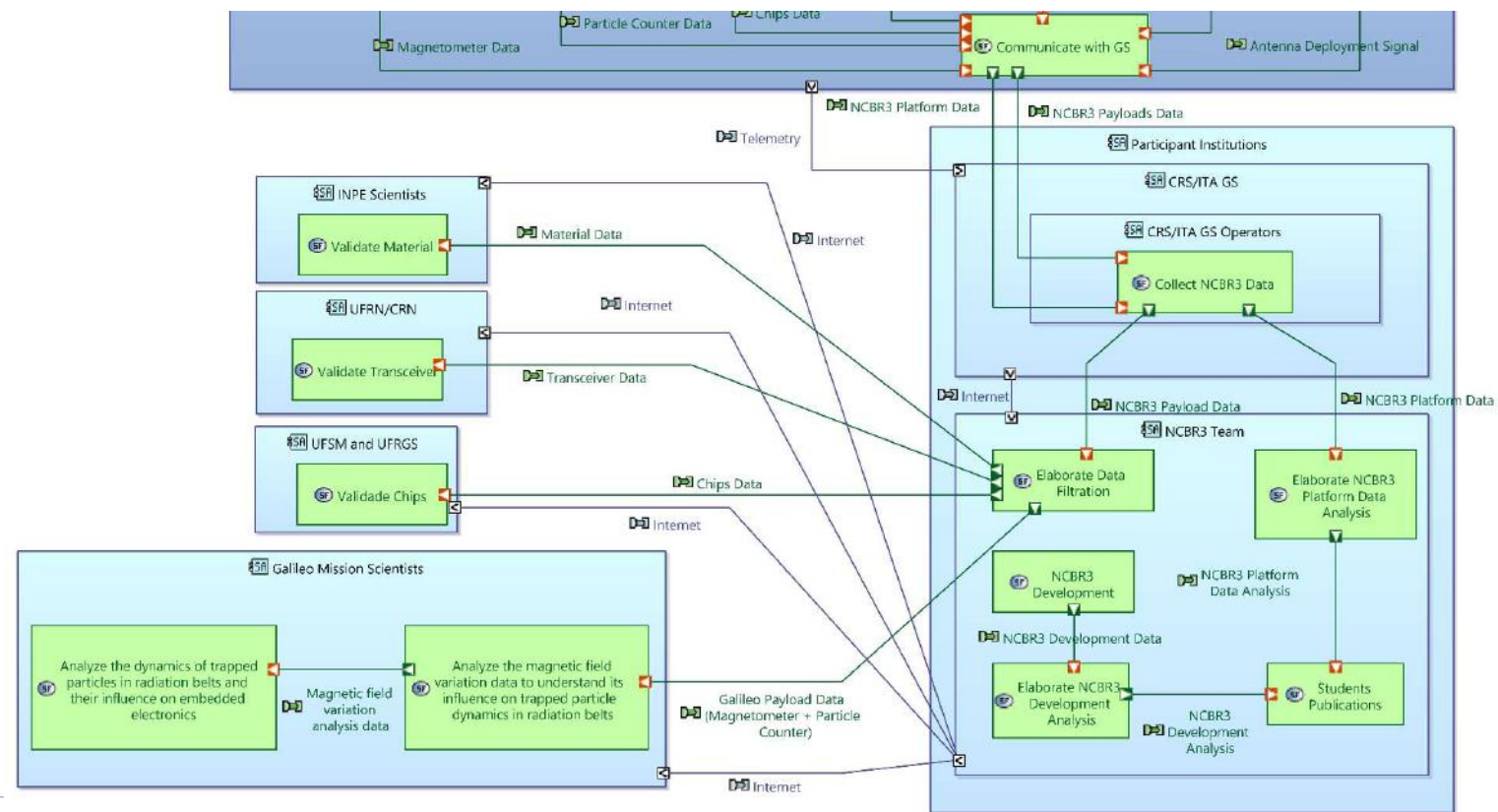

Figure 9: System Architecture

NCBR3 MISSION CONCEPT

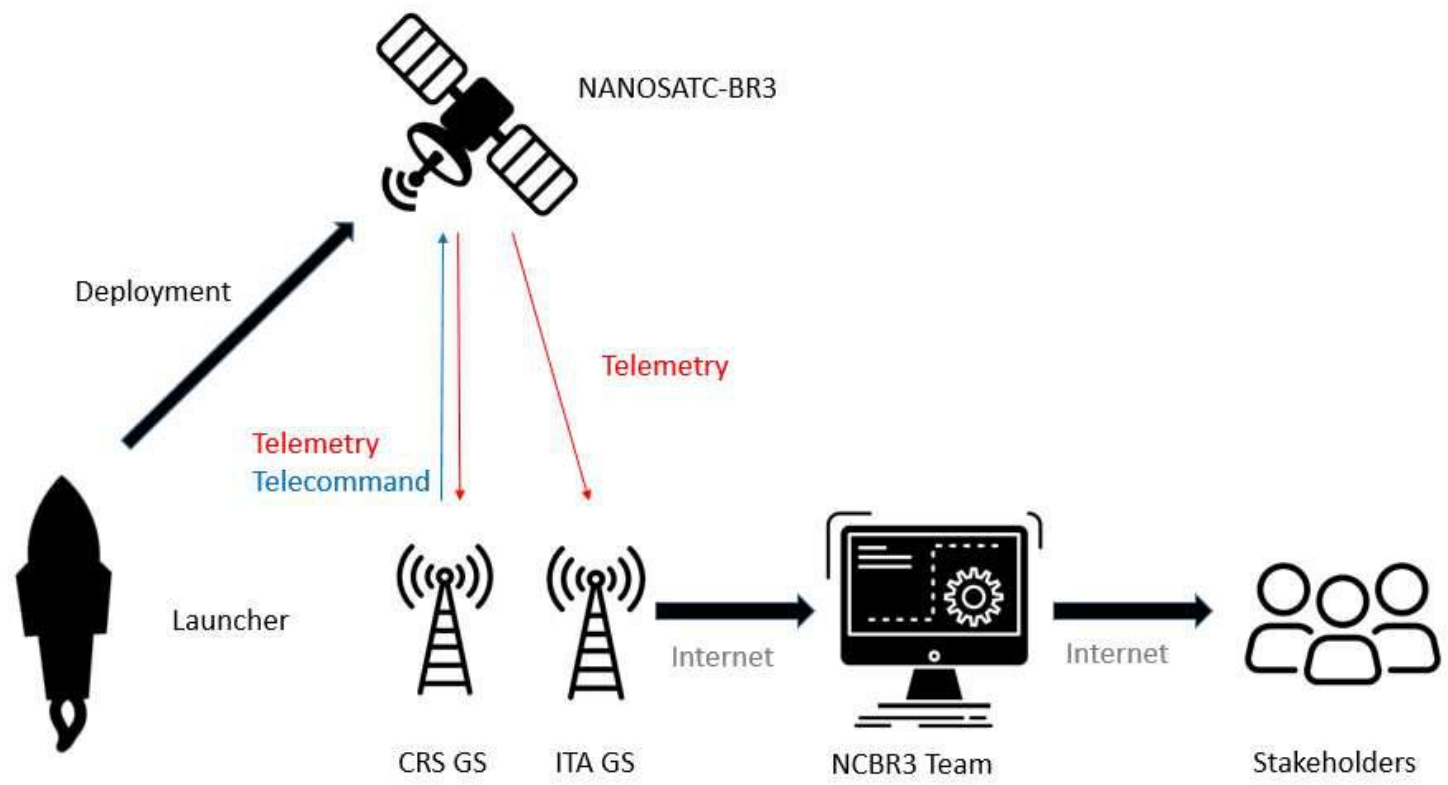

Figure 10: NCBR3 Mission Concept



DISCUSSION

- **MBSE** main contributions:
 - Hidden requirements;
 - Improve communication;
 - Visual tool – unify system understanding;
 - System boundaries and basic functions;
 - Viable system concept;
 - Reduced project paper work;
 - Traceability raises reliability.



CONCLUSIONS

- **MBSE:**
 - Made possible a much more structured mission **Phase 0**;
 - Has educational purposes competence;
 - **Consolidates** and **unifies** understanding;
 - Very useful to Project Reviews.

- **Future Works:**
 - Further modeling through next steps;
 - Encourage MBSE culture within NANOSATC-BR Program.



ACKNOWLEDGMENTS

To:



- The authors thank the **Brazilian Space Agency - AEB, SEXEC/MCTIC, COCRE/INPE-MCTIC, UFSM-FATEC** for the support, opportunity and grants for the Brazilian INPE-UFSM NANOSATC-BR Cubesat Development Program, with its CubeSats: the NANOSATC-BR1, NANOSATC-BR2 & the NANOSATC-BR3 Projects.
- The authors thank and acknowledge to **Eng. Abe Bonnema and the ISIS's Board of Directors** for the support to the Brazilian students and for the NANOSATC-BR, CubeSats Development Program, the NANOSATC-BR1, NANOSATC-BR2 & the NANOSATC-BR3 Projects.
- Dr. Nelson Jorge Schuch thanks the **National Council for Scientific and Technological Development (CNPq)** for the fellowship under the number 300886/2016-0. The authors thank to MCTIC-CNPq/(INPE/PCI-PIBIC-PIBIT) and to FATEC Programs for fellowships.



The NANOSATC-BR Program site is: www.inpe.br/crs/nanosat/



**Muito
Obrigado**



Thanks

Grazie

ARTUR GUSTAVO SLONGO
arturgustavoslongo@gmail.com



International Academy of Astronautics - IAA
**5th IAA Conference on University Satellite Missions and CubeSat
Workshop**

